



Celebrate

NEW

EN > Inspired by worldwide recognized BIC® cap, the new BIC® Celebrate embodies the timeless style reminiscent of legendary BIC® Cristal®.

*The iconic premium
gift that everyone
was waiting for!*





Celebrate NEW

- FR > Inspiré du design du capuchon BIC® célèbre dans le monde entier, le nouveau BIC® Celebrate incarne le style intemporel du mythique BIC® Cristal®. Le cadeau premium icône que vous attendiez tous!
- ES > Inspirado en el diseño del tapón BIC® reconocido mundialmente, el nuevo BIC® Celebrate encarna el estilo atemporal del mítico BIC® Cristal®. ¡El icónico regalo premium que todos estaban esperando!
- DE > Inspiriert von der weltweit anerkannten BIC®-Kappe verkörpert der neue BIC® Celebrate den zeitlosen Stil des legendären BIC® Cristal®. Das Premium-Kultgeschenk, auf das alle gewartet haben!
- IT > Ispirato al design del tappo BIC® riconosciuto a livello mondiale, la nuova BIC® Celebrate incarna lo stile senza tempo della mitica BIC® Cristal®. L'iconico prodotto regalo che tutti aspettavano!



1602 Gold /
1603 Silver
Ballpen
Bille
Bolígrafo
Kugelschreiber
Sfera



A> SP: max. 1 colour

1602 Gold
Barrel and Cap
OPAQUE
26

1603 Silver
Barrel
OPAQUE
47

MOQ: 250 u. + 3.6 Kg



Media Max

EN > Mix&Match colour combination offered in up to 5 different parts: barrel, grip, section, clip and button!





Media Max

- FR > Avec Mix&Match, associez les couleurs sur 5 parties différents : corps, grip, section, clip et bouton ! Maximisez votre message avec le best-seller de notre gamme XL!
- ES > Combina con Mix&Match los colores en hasta 5 partes diferentes: cuerpo, grip, sección, clip y botón! ¡Maximiza tu mensaje con el superventas de perfil ancho en Europa!
- DE > Kombinieren Sie mit Mix&Match die Farben von bis zu 5 verschiedenen Teilen: Schaft, Griffzone, Teilstück, Clip und Druckknopf! Maximal klare Botschaft mit dem Breitprofil-Bestseller in Europa!
- IT > Abbina con Mix&Match fino a 5 diverse parti colorate: corpo, grip, sezione, clip e pulsante! Massimizza il tuo messaggio con il best seller Europeo dalla sezione larga.



1030 / 1033

1030
Ballpen
Bille
Bolígrafo
Kugelschreiber
Sfera

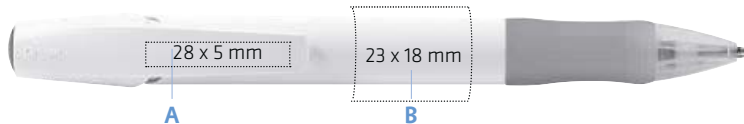

1033
Mechanical pencil
Porte-mines
Portaminas
Druckbleistift
Portamine

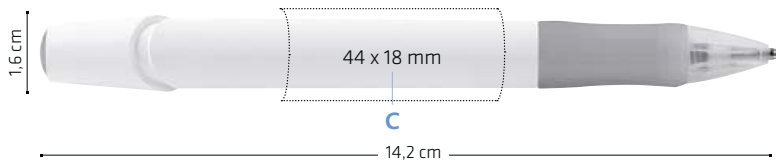

A > SP: max. 2 colours
B / C > SP: max. 3 colours



Barrel, Clip, Grip, Button and Section

OPAQUE				FROSTED			
01	02	03	38	4B	39	40	
04	05	07	63	66	67	68	
10	12	18	69	71	82		

MOQ: 500 U.

PMS SERVICE
≥ 10.000 U.



*Except pencil

Red ink available under request
BIC® Easy-Glide Ink™ option



Media Max Digital



- EN > 360° photo quality full colour imprint.
- FR > Impression 360° de qualité photographique.
- ES > Impresión 360° a todo color con calidad fotográfica.
- DE > 360°-Vollfarbdruck in Fotoqualität.
- IT > Stampa di qualità fotografica a colori a 360°.



1874
Ballpen
Bille
Bolígrafo
Kugelschreiber
Sfera

1877
Mechanical pencil
Porte-mines
Portaminas
Druckbleistift
Portamine

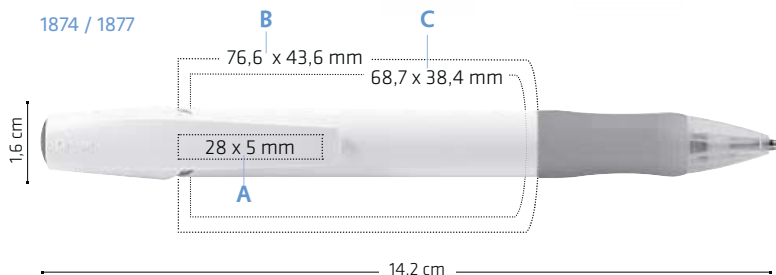

- A > SP: max. 2 colours
- B > DG: full colour (area for images)
- C > DG: full colour (area for text)



Clip, Grip, Button and Section

OPAQUE



FROSTED



Barrel
OPAQUE



MOQ: 500 u.

PMS SERVICE
≥ 10.000 u.



500
± 6 Kg



Red ink available under request
BIC® Easy-Glide Ink™ option



Media Max Premium

- EN > Premium metallic colour finish.
- FR > Finition métallisée haut de gamme.
- ES > Acabado metálico premium.
- DE > Hochwertige Metalloptik.
- IT > Finiture in metallo.



1D30 / 1D33

1D30
Ballpen
Bille
Bolígrafo
Kugelschreiber
Sfera

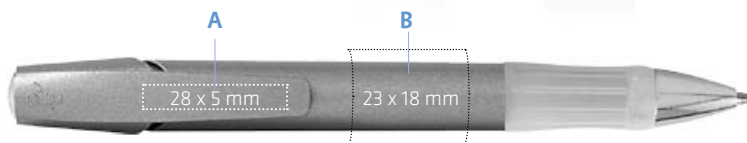

1D33
Mechanical pencil
Porte-mines
Portaminas
Druckbleistift
Portamine

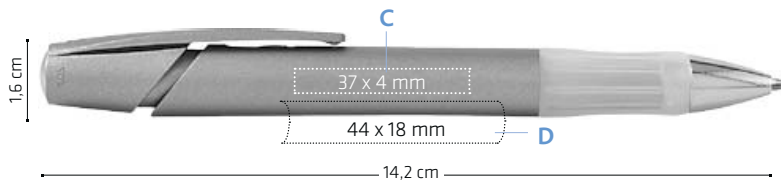

A > SP: max. 2 colours
B / D > SP: max. 3 colours
C > LE



Button and Section

35

Grip

02 09

Barrel and Clip

4A 5A 6A
7A 8A 9A

MOQ: 250 u.



250



* Except pencil

Red ink available under request
BIC® Easy-Glide Ink™ option



Media Max Premium Digital



- EN > Full colour imprint combined with premium metallic colour finish.
- FR > Impression couleur avec finition premium pour les coloris métalliques.
- ES > Impresión a todo color con acabado premium en colores metálicos.
- DE > Vollfarbdruck mit Premiumfinish in Metallicfarben.
- IT > Stampa full colour con finiture premium in colori metallici.



1883

1884

1883 / 1884



B

C

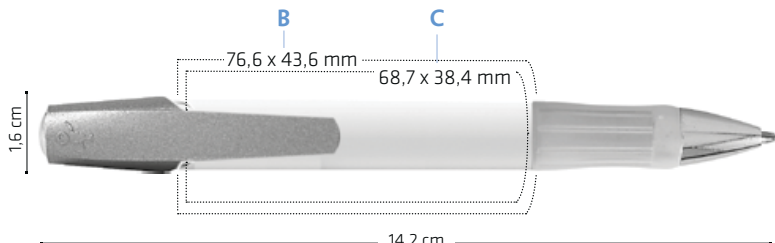

1883
Ballpen
Bille
Bolígrafo
Kugelschreiber
Sfera

1884
Mechanical pencil
Porte-mines
Portaminas
Druckbleistift
Portamine

- A> SP: max. 2 colours
- B> DG: full colour (area for images)
- C> DG: full colour (area for text)



Button and Section

35

Grip

02 69

Clip

4A 5A 6A
7A 8A 9A

Barrel
OPAQUE

01

MOQ: 500 u.



250
± 5.3 Kg



Red Ink available under request
BIC® Easy-Glide Ink™ option



Atlantis®

- EN > Ergonomic design and rubber grip for a comfortable writing experience.
- FR > Forme ergonomique et grip en caoutchouc pour une expérience d'écriture confortable.
- ES > Diseño ergonómico y grip de goma para una cómoda experiencia de escritura.
- DE > Ergonomisches Design und Gummigriffzone für ein komfortables Schreiberlebnis.
- IT > Design ergonomico e grip in gomma per un'esperienza di scrittura confortevole.



1053 / 1060 Clear

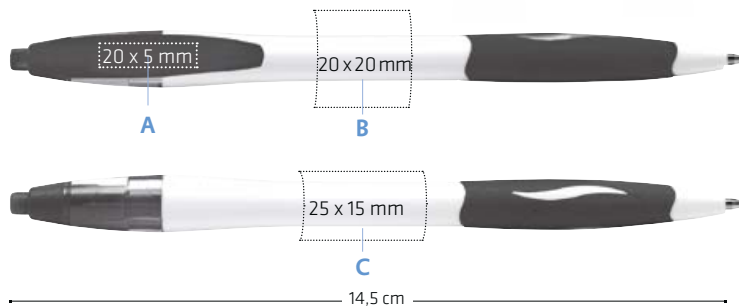

1053 / 1060 Clear
 Ballpen
 Bille
 Bolígrafo
 Kugelschreiber
 Sfera

A> SP: max. 1 colour
 B / C> SP: max. 2 colours

1053

Barrel / Trims / Ink
 OPAQUE



1060 Clear

Barrel / Trims / Ink
 CLEAR / OPAQUE

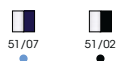

MOQ: 250 u.



Clic & Clic Gold



- EN >** Made 25% of cellulosic polymers, an eco-friendly material manufactured using natural, renewable softwood materials. BIC® Clic is flexible and durable as well as pleasant to touch, and is offered in a wide variety of colours and finishes.
- FR >** Fabriqué avec 25 % de polymères de cellulose, matériau écologique obtenu à partir du bois, BIC® Clic est flexible et durable, agréable au toucher et il existe dans une vaste gamme de coloris et de finitions.
- ES >** Fabricado en un 25% de polímeros de celulosa, un material ecológico realizado a partir de la madera. BIC® Clic es flexible y duradero así como agradable al tacto, y se ofrece en una amplia gama de colores y acabados.
- DE >** Zu 25 % aus Zellulosepolymeren gefertigt, ein aus Holz hergestelltes ökologisches Material. BIC® Clic ist flexibel, hält lange, ist angenehm anzufassen und wird in einer breiten Palette an Farben und Finishes angeboten.
- IT >** Prodotto al 25% con polimeri di cellulosa, un materiale ecologico realizzato partendo dal legno. BIC® Clic è flessibile e di lunga durata, ma anche piacevole al tatto, e disponibile in una vasta gamma di colori e finiture.



1093

100%

1091

100%

1090

1093 / 1091 Gold / 1090 Gold Clear

1093 /
1091 Gold /
1090 Gold Clear
Ballpen
Bille
Bolígrafo
Kugelschreiber
Sfera

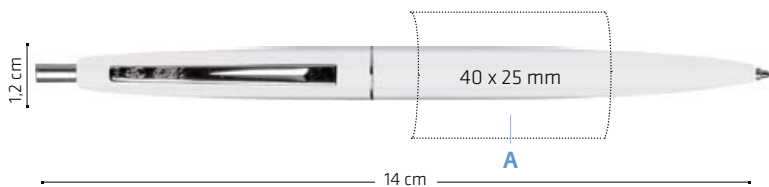

A> SP: max. 3 colours

1093
Barrel / Trims
OPAQUE



1091 Gold
Barrel / Trims / Ink
OPAQUE

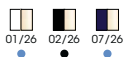

1090 Gold Clear
Barrel / Trims / Ink
FROSTED



MOQ: 250 u. + 2.3 Kg

*Except for 34



Citation

- EN > Polished nickel plated trim.
- FR > Attributs en nickel poli.
- ES > Atributos plateados de nickel pulido.
- DE > Beschläge vernickelt und poliert.
- IT > Particolari cromati in nickel.



1620
Ballpen
Bille
Bolígrafo
Kugelschreiber
Sfera

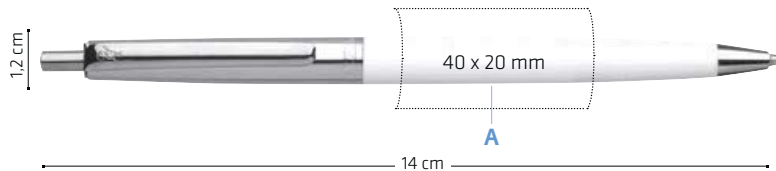

A> SP: max. 2 colours

Barrel
OPAQUE CLEAR
01 02 07 86

MOQ: 250 u. M 250 ±1.3 Kg



4 Colours

EN > Four different ink colours in one! Break-away lanyard also available.
This iconic family now grows with the new BIC® 4 Colours Shine!

*A classic that's
always in
fashion!*



*Simple, inventive,
reliable!*





4 Colours

- FR > Quatre couleurs d'encre différentes en un stylo! Possibilité d'insérer un lanyard avec fermeture de sécurité.
- ES > ¡4 colores diferentes de tinta en un producto! Lanyard con cierre de seguridad también disponible.
- DE > Vier Tintenfarben in einem Schreibgerät! Break-Away Lanyard ebenfalls verfügbar.
- IT > Quattro differenti colori di inchiostro in un'unica sfera! Disponibile anche lanyard con chiusura di sicurezza.



1100 / 1101 Lanyard
Ballpen
Bille
Bolígrafo
Kugelschreiber
Sfera

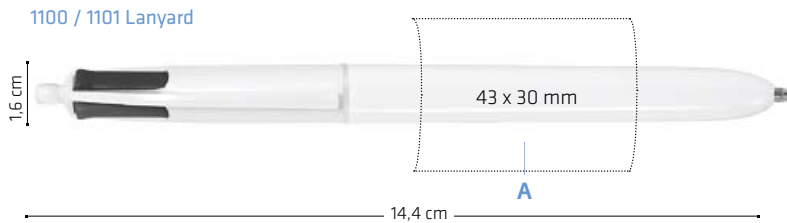

A > SP: max. 4 colours

1100 / 1101 Lanyard

Cap and Barrel
OPAQUE



MOQ: 250 u.

1100	1101
250	300
± 3.2 Kg	± 6 Kg

MADE IN FRANCE

* Only for 1100



4 Colours Mini

- EN > Four different ink colours in one!
Even more functional with a reduced size.
Break-away lanyard also available.
- FR > Quatre couleurs d'écriture dans un stylo.
Plus fonctionnel maintenant grâce à sa taille réduite.
Possibilité d'insérer un lanyard avec fermeture de sécurité.
- ES > ¡4 colores diferentes de tinta en un producto!
Todavía más práctico con un tamaño reducido
Lanyard con cierre de seguridad también disponible.
- DE > Vier verschiedene Tintenfarben in einem Schreibgerät. Noch funktioneller in reduzierter Größe.
Break-Away Lanyard ebenfalls verfügbar.
- IT > Quattro colori di inchiostro differenti in un unico prodotto!
Ancora più funzionale con una dimensione ridotta.
Disponibile anche lanyard con chiusura di sicurezza.



1103
1104 Lanyard
Ballpen
Bille
Bolígrafo
Kugelschreiber
Sfera



A> SP: max. 4 colours

1103 / 1104 Lanyard
Cap and Barrel
OPAQUE



MOQ: 250 u.

1103	1104	
250	300	MADE IN FRANCE
+ 2.7 Kg	+ 5.5 Kg	

* Only for 1103



4 Colours Shine

NEW

EN > The iconic BIC® 4 Colours family welcomes its new metallic colour ballpen. It features 4 standard colour inks: blue, black, red and green. The new BIC® 4 Colours Shine, shines by itself!

FR > La famille iconique BIC® 4 Colours souhaite la bienvenue à son petit dernier avec une finition métallique. Il comporte 4 coloris standard d'encre : bleu, noir, rouge et vert. Le nouveau BIC® 4 Colours Shine brille de mille feux!

ES > La icónica familia BIC® 4 Colours da la bienvenida a su nuevo bolígrafo con acabado metálico. Presenta 4 colores estándar de tinta: azul, negro, rojo y verde. El nuevo BIC® 4 Colours Shine brilla con luz propia!

DE > Die Kultfamilie BIC® 4 Colours heißt den neuen Kugelschreiber mit Metallic-Finish willkommen. 4 Standard-Tintenfarben: Blau, Schwarz, Rot, Grün. Der neue BIC® 4 Colours Shine glänzt aus eigener Kraft!

IT > L'iconica famiglia BIC® 4 Colours dà un caldo benvenuto alla nuova penna con finitura metallica. Disponibile con inchiostro di 4 colori standard: blu, nero, rosso e verde. Il nuovo BIC® 4 Colours Shine brilla di luce propria!



1106
Ballpen
Bille
Bolígrafo
Kugelschreiber
Sfera

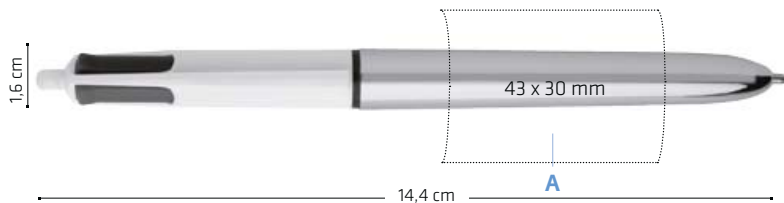

A> SP: max. 2 colours

Cap and Barrel
OPAQUE



MOQ: 250 u.



250
± 3.2 Kg





4 Colours Fashion

EN > Useful and trendy! BIC® 4 Colours Fashion is dressed in a charming apple green and white barrel, featuring 4 fashion ink colours: ultramarine blue, deep purple, acid green and girly pink.

FR > Pratique et à la mode! BIC® 4 Colours Fashion s'habille d'un corps vert pomme ou blanc et comporte 4 encres modernes: bleu ultramarin, pourpre sombre, vert acide et rose chewing-gum.

ES > Práctico y a la moda! BIC® 4 Colours Fashion viste con cuerpo verde manzana o blanco, y presenta 4 modernas tintas: azul ultramarino, púrpura oscuro, verde ácido y rosa chicle.

DE > Praktisch und trendy! BIC® 4 Colours Fashion im apfelgrünen oder weißen Schaft mit 4 modernen Tinten: Ultramarin-Blau, Intensiv-Lila, Acid-Grün und Girly-Rosa.

IT > Pratico e alla moda! BIC® 4 Colours Fashion è rivestito di un corpo verde mela o bianco e offre 4 moderni inchiostri: blu oltremare, viola scuro, verde acido e rosa chewing gum.



1102
Ballpen
Bille
Bolígrafo
Kugelschreiber
Sfera

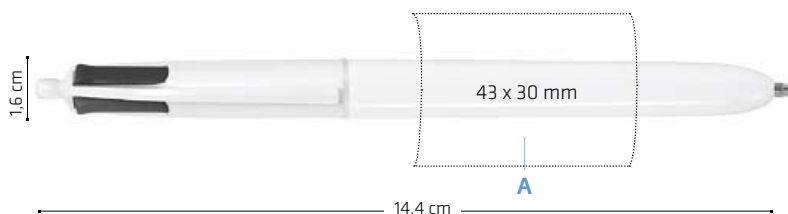

A> SP: max. 4 colours

Cap and Barrel
OPAQUE



01/01 01/59





2 in 1 Stylus

NEW

- EN > Lightweight stylus for capacitive touchscreen devices, including tablets and smartphones! Easily glides across screens providing fingerprint-free precision and control.
- FR > Stylus léger pour écrans tactiles, tablettes et smartphones ! Glisse facilement sur les écrans en offrant une précision et un contrôle sans traces de doigt.
- ES > ¡Puntero para dispositivos de pantalla capacitiva, como tablets y smartphones! Deslizamiento preciso y suave en pantallas táctiles para evitar huellas.
- DE > Leichter Eingabestift für kapazitive Touchscreengeräte, einschließlich Tablets und Smartphones! Gleitet leicht über die Screens, sorgt für Präzision und Kontrolle ohne Fingerabdrücke.
- IT > Pennino leggero per dispositivi touchscreen, compresi tablet e smartphone! Scivola facilmente su qualsiasi schermo con precisione e controllo senza lasciare impronte.



1094
Ballpen
Bille
Bolígrafo
Kugelschreiber
Sfera



A> SP: max. 2 colours

Cap and Barrel
OPAQUE



02/02

MOQ: 50 u.



+ 2,8 Kg



Triumph 537R

- EN > Smooth writing roller.
Barrel wrapped in metallic colour
- FR > Roller à écriture fluide.
Corps recouvert d'un plastique métallisé.
- ES > Suave escritura roller.
Cuerpo envuelto con un plastificado metalizado.
- DE > Rollerball mit angenehmem Schreibkomfort.
Schaft personalisierbar im 360° Metall-Druck
- IT > Roller dal tratto fluido.
Corpo con rivestimento in plastica metallizzata.



1197
Roller Ball
Stylo roller
Roller
Rollerball
Roller



A> SP: max. 1 colour

Barrel / Ink
OPAQUE



Clip / Trims



MOQ: 250 u.



400

Ø 0,7mm

± 2,6 Kg



Grip Roller

- EN > Fast drying ink for clean and precise writing.
- FR > Encre à séchage rapide pour une écriture propre et précise.
- ES > Tinta de secado rápido para una escritura limpia y precisa.
- DE > Schnell trocknende Tinte für sauberes und präzises Schreiben.
- IT > Inchiostro ad asciugatura rapida per una scrittura pulita e precisa.



1195

1187

100%

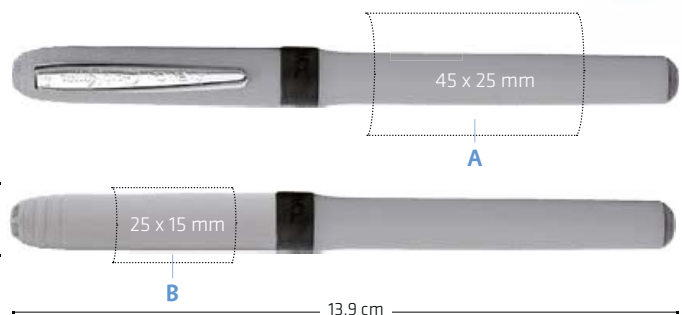

A/B> SP: max. 2 colours

1187 /
1195 Gold
Roller Ball
Stylo roller
Roller
Rollerball
Roller

1187
Barrel and Cap / Clip / Ink
OPAQUE

01/35	02/35	03/35	06/35	07/35	24/35

195 Gold
Barrel and Cap / Clip / Ink
OPAQUE

02/26

MOQ: 250 u. R

Ø 0,7mm ± 3 Kg



XS Finestyle

- EN > Super-smooth roller with Finestyle ink point: you will love the writing experience!
- FR > Super doux avec pointe feutre fine: vous allez aimer écrire!
- ES > Roller súper suave con punta Finestyle: ¡va a amar la experiencia de escritura!
- DE > Extrem sanft gleitender Rollerball mit Finestyle-Spitze: Dieses Schreiberlebnis werden Sie lieben!
- IT > Roller ultra morbido con punta Finestyle: ti innamorerai dell'esperienza della scrittura!



1851 / 1856 Clear
Finestyle
Feutre pointe fine
Escritura fina
Fineliner
Finestyle



A> PD: max. 4 colours
B> SP: max. 1 colour

1851
Barrel and Clip / Trims / Ink
OPAQUE



1856 Clear
Clip, Barrel and Trims / Ink
OPAQUE / CLEAR



MOQ: 500 u.



Intensity® Gel Clic

- EN > Ultra-smooth gel roller.
Chrome plated section.
- FR > Roller à encre gel ultra-doux.
Section en chrome poli.
- ES > Roller de gel ultra suave.
Sección cromada.
- DE > Gel-Tinte für angenehmen
Schreibkomfort.
Verchromte Spitze.
- IT > Roller gel con scrittura
ultra-fluida.
Puntale cromato.

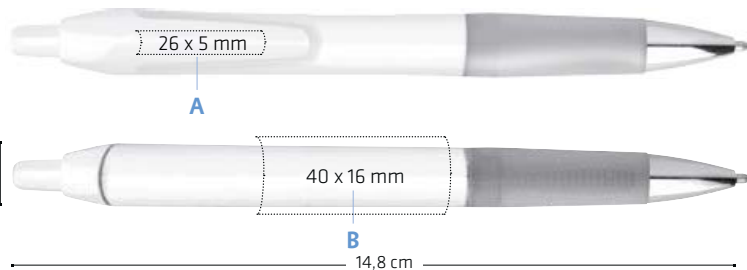

1196
Gel
Gel
Gel
Gelschreiber
Gel

A> SP: max. 1 colour
B> SP: max. 2 colours

Barrel
CLEAR



OPAQUE



MOQ: 250 u.



± 0,7mm



Velocity[®] Gel NEW

- EN > Ultra-smooth gel roller. Ergonomic soft touch grip.
- FR > Roller à gel ultra doux. Grip ergonomique au toucher doux.
- ES > Roller de gel ultra suave. Grip ergonómico de tacto suave.
- DE > Extrem sanft gleitender Gelroller. Ergonomische Soft-Touch-Griffzone.
- IT > Roller a inchiostro gel ultra morbido. Grip ergonomico morbido al tatto.



1188
Ballpen
Bille
Bolígrafo
Kugelschreiber
Sfera

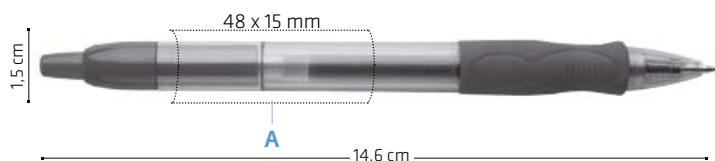

A> SP: max. 1 colour

Barrel / Trims / Ink
CLEAR OPAQUE



MOQ: 250 u.



± 2,6 Kg





Great Erase White Board Marker

- EN > Ideal for use on dry erase boards, glass and most non-porous surfaces. Easily erases with a dry cloth, tissue or felt eraser!
- FR > Convient parfaitement pour une utilisation sur tableau blanc, le verre et la plupart des surfaces non poreuses. S'efface facilement avec un chiffon sec, un papier-mouchoir ou un effaceur-feutre!
- ES > Ideal para usarlo en pizarras blancas, cristal y la mayoría de superficies no porosas. ¡Borra fácilmente con un paño seco, un pañuelo o un borrador de fieltro!
- DE > Besonders für den Gebrauch auf trockenen, abwischbaren Tafeln, Glas und den meisten nicht porösen Oberflächen geeignet. Leicht mit einem trockenen Lappen, Papiertuch oder Filzschwamm abwischbar.
- IT > Perfetto da usare su lavagne cancellabili a secco, vetro e la maggior parte delle superfici non-porose. Si cancella facilmente con un panno asciutto, un fazzoletto o un cancellino in feltro!



100%

1213
Marquer
Marqueur
Marcador
Permanent Marker
Marcatore

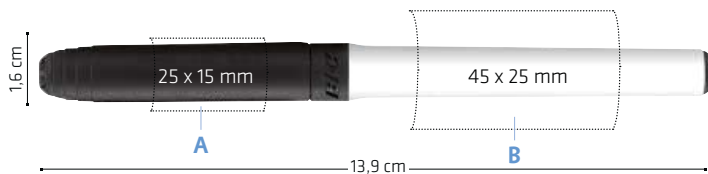

A/B > SP: max. 2 colours

Barrel / Cap and Trims / Ink
OPAQUE



01/02

MOQ: 250 u.



250

+ 2.7 Kg



Mark-it Permanent Marker

- EN > Fade-resistant, bright ink.
- FR > Encre vive, résistante à la décoloration.
- ES > Tinta intensa, resistente a la pérdida de color.
- DE > Leuchtende Tinte, bleicht nicht aus..
- IT > Inchiostro intenso, resistente allo sbiadimento.



1214
Marquer
Marqueur
Marcador
Permanent Marker
Marcatore

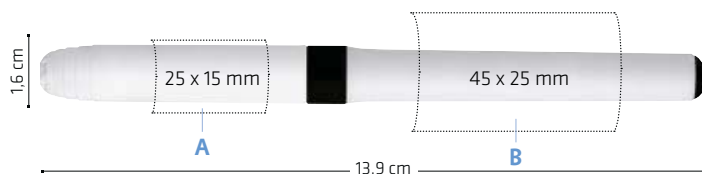

A/B> SP: max. 2 colours

Barrel and Cap / Trims / Ink
OPAQUE



MOQ: 250 u.   250 



Permanent Marker

- EN > Writes on virtually any surface. Large imprint area.
- FR > Écrit sur quasiment toutes les surfaces. Large zone d'impression.
- ES > Escribe sobre cualquier superficie. Amplia área de impresión.
- DE > Schreibt auf praktisch allen Oberflächen. Große Druckfläche.
- IT > Scrive su qualsiasi superficie. Ampia area di stampa.



100%

1210
 Marquer
 Marqueur
 Marcador
 Permanent Marker
 Marcatore

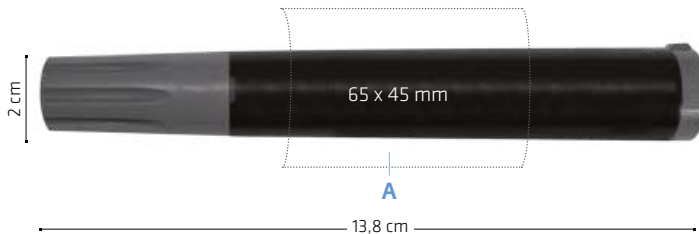

A> SP: max. 1 colour

Barrel / Cap / Ink
OPAQUE



MOQ: 250 u.



Brite Liner® Grip

- EN > Highlight your message.
- FR > Souligne votre message
- ES > Resalta tu mensaje.
- DE > Markieren Sie Ihre Werbebotschaft.
- IT > Evidenzia il tuo messaggio.



100%

1192
Highlighter
Surligneur
Resaltador
Leuchtmarker
Evidenziatore

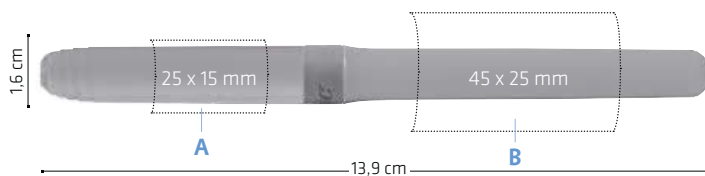

A> SP: max. 2 colours
B> SP: max. 1 colour

Barrel
OPAQUE



MOQ: 250 u.



250

+ 2.8 Kg



Brite Liner® Grip XL

- EN > Chisel tip for broad highlighting and fine underlining. Textured rubber grip for comfort and control.
- FR > Pointe ciselée pour surligner et soulignement fin. Grip en caoutchouc texturé pour plus de confort et de contrôle d'écriture.
- ES > Punta cincelada para remarcar en grueso y subrayar en fino. Grip de goma con relieve para mayor comodidad y control.
- DE > Abgeschrägte Spitze für breites Markieren und feines Unterstreichen. Strukturierte Gummi-Griffzone für komfortables, sicheres Schreiben.
- IT > Punta a scalpello per un'evidenziazione larga e una sottolineatura perfetta. Grip in gomma tramata per una impugnatura confortevole.



1193
Highlighter
Surligneur
Resaltador
Leuchtmarker
Evidenziatore

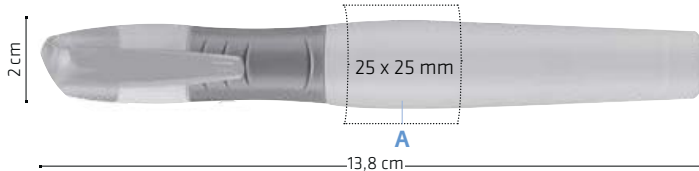

A> SP: max. 1 colour

Barrel
OPAQUE



MOQ: 250 u.



125
+ 2.8 Kg



Evolution Classic



- EN > Synthetic resin and wood-free.
- FR > Résine synthétique et sans bois.
- ES > Resina sintética que no contiene maderar.
- DE > Aus Kunstharz. Holzfrei.
- IT > Resina sintetica senza fibra legnosa.

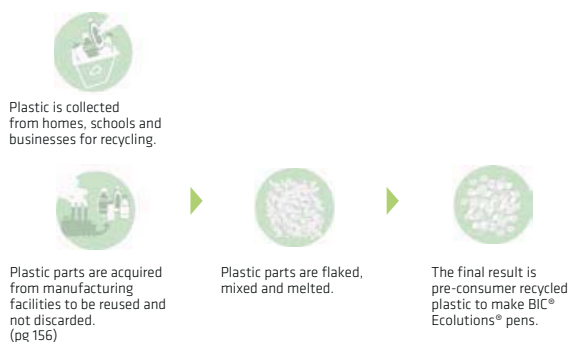

** Made with 54% recycled plastic (1150)

* Made with 46% recycled plastic (1151)

The percentage is calculated on the total weight of the product.

Add the mobius loop to your artwork at no additional charge. Please be sure to specify "Print the mobius loop" on your order. (Mobius loop imprint defaults to lower left hand corner.)



1150**
 Graphite pencil cut end
 Crayon graphite bout coupé
 Lápiz de grafito sin goma
 Graphit-Bleistift ohne Radiergummi
 Matita di grafite senza gomma

1151*
 Graphite pencil with eraser
 Crayon graphite bout gomme
 Lápiz de grafito con goma
 Graphit-Bleistift mit Radiergummi
 Matita di grafite con gomma

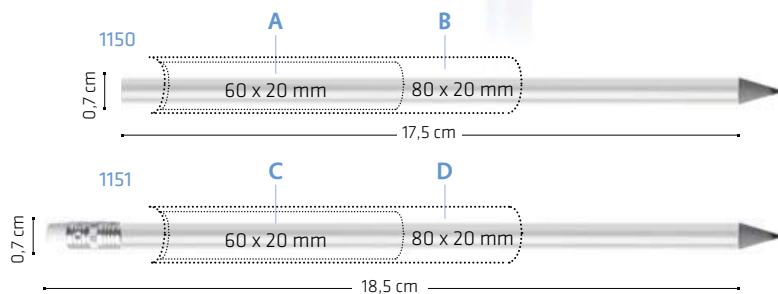

A/C> SP: max. 2 colours
 B/D> SP: max. 1 colour

Barrel
 OPAQUE



MOQ: 500 u.

*Only cut end & not sharpened

Evolution Digital



- EN > 360° photo quality full colour imprint.
- FR > Impression 360° de qualité photographique.
- ES > Impresión 360° a todo color con calidad fotográfica.
- DE > 360°-Vollfarbdruck in Fotoqualität.
- IT > Stampa di qualità fotografica a colori a 360°.



Plastic is collected from homes, schools and businesses for recycling.



Plastic parts are acquired from manufacturing facilities to be reused and not discarded. (pg 156)



Plastic parts are flaked, mixed and melted.



The final result is pre-consumer recycled plastic to make BIC® Ecolutions® pens.

** Made with 54% recycled plastic (1879)

* Made with 46% recycled plastic (1871)

The percentage is calculated on the total weight of the product.

Add the mobius loop to your artwork at no additional charge. Please be sure to specify "Print the mobius loop" on your order. (Mobius loop imprint defaults to lower left hand corner.)



1879**
Graphite pencil cut end
Crayon graphite bout coupé
Lápiz de grafito sin goma
Graphit-Bleistift ohne Radiergummi
Matita di grafite senza gomma

1871**
Graphite pencil with eraser
Crayon graphite bout gomme
Lápiz de grafito con goma
Graphit-Bleistift mit Radiergummi
Matita di grafite con gomma

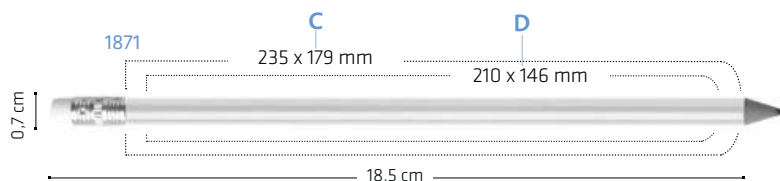
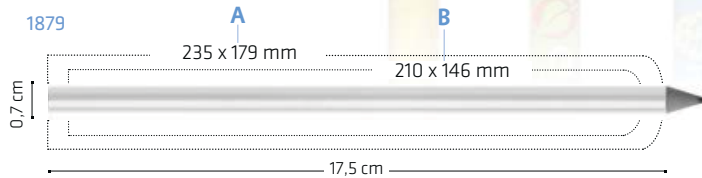

A/C > DG: full colour (area for images)
B/D > DG: full colour (area for text)



Barrel
OPAQUE

01

MOQ: 500 u. PC

500
± 3.5 Kg





Evolution Colour Connection



- EN > Mix&Match the colour of the components.
- FR > Associez les coloris des composants avec Mix&Match.
- ES > Combine el color de los componentes con Mix&Match.
- DE > Kombinieren Sie die Farben der Bestandteile mit Mix&Match.
- IT > Combina il colore dei componenti con Mix&Match.



Plastic is collected from homes, schools and businesses for recycling.



Plastic parts are acquired from manufacturing facilities to be reused and not discarded. (pg 156)



Plastic parts are flaked, mixed and melted.



The final result is pre-consumer recycled plastic to make BIC® Ecolutions® pens.

*** Made with 46% recycled plastic**

The percentage is calculated on the total weight of the product.

Add the mobius loop to your artwork at no additional charge. Please be sure to specify "Print the mobius loop" on your order. (Mobius loop imprint defaults to lower left hand corner)



80%

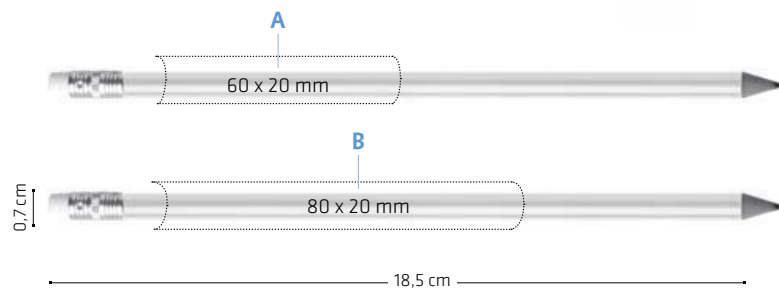

1154
Graphite pencil with eraser
Crayon graphite bout gomme
Lápiz de grafito con goma
Graphit-Bleistift mit Radiergummi
Matita di grafite con gomma

A> SP: max. 2 colours
B> SP: max. 1 colour

Barrel OPAQUE	Eraser	Ferrule

MOQ: 500 u. + 3.5 Kg

Evolution Digital Colour Connection



- EN > Mix&Match the components and print 360° full colour!
- FR > Associez les composants avec Mix&Match et imprimez à 360° en couleur!
- ES > ¡Combina los componentes con Mix&Match e imprime a 360° a todo color!
- DE > Kombinieren Sie die Farben der Bestandteile mit Mix&Match und wählen Sie 360°-Vollfarbdruck!
- IT > Combina i componenti con Mix&Match e stampa a 360° a colori!



Plastic is collected from homes, schools and businesses for recycling.



Plastic parts are acquired from manufacturing facilities to be reused and not discarded. (pg 156)



Plastic parts are flaked, mixed and melted.



The final result is pre-consumer recycled plastic to make BIC® Ecolutions® pens.

*** Made with 46% recycled plastic**

The percentage is calculated on the total weight of the product.

Add the mobius loop to your artwork at no additional charge. Please be sure to specify "Print the mobius loop" on your order. (Mobius loop imprint defaults to lower left hand corner)



80%

1885
Graphite pencil with eraser
Crayon graphite bout gomme
Lápiz de grafito con goma
Graphit-Bleistift mit Radiergummi
Matita di grafite con gomma

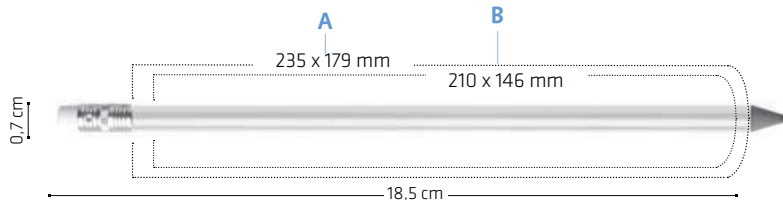

A> DG: full colour (area for images)
B> DG: full colour (area for text)

Barrel
OPAQUE

Eraser

Ferrule



01

01 02 07 10
12 14 59

02 20 26
34 47

MOQ: 500 u. PC

500

+ 3,5 Kg





Matic®

- EN > Provide write-out equivalent to 2^{1/2} woodcase pencils!
Scantron Certified to be used in forms, test or machine-readable questionnaires.
Three 0.7mm #2 graphite leads (HB).
- FR > Offre une durée d'écriture 2 fois et 1/2 supérieure aux crayons de bois!
Certifiés Scantron pour utilisation sur des formulaires, tests, ou questionnaires lisibles par machine.
Trois mines de graphite n°2 de 7mm (HB).
- ES > Proporciona una longitud de escritura equivalente a 2,5 lápices de madera!
Certificado por Scantron para uso en formularios, test o cuestionarios de lectura automática.
Tres recambios de grafito de 0,7mm (HB).
- DE > Entspricht einer Schreiblänge von zweieinhalb Holzbleistiften!
Scantron-geprüft: geeignet für Fragebögen, Examina und Lesemaschinen. Drei 0,7 mm Graphit-Minen (HB).
- IT > Scrive circa 2 volte e mezzo una normale matita in legno!
Certificato Scantron, lettore di marcature ottiche usato per valutazione di esami universitari, test e questionari ufficiali.
Tre mine grafite da 0.7mm (HB).



100%

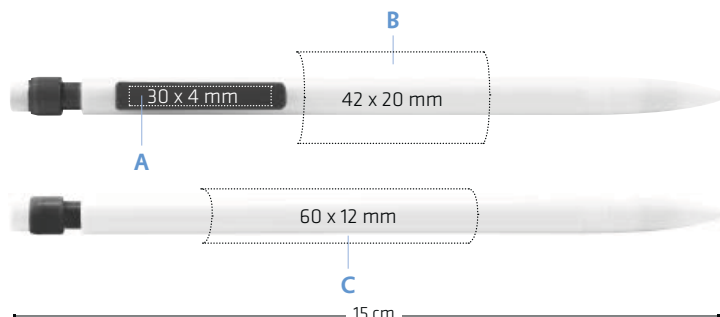

A> SP: max. 1 colour
B/C> SP: max. 2 colours

Barrel and Trims OPAQUE



MOQ: 500 u.



500
± 3.1 Kg

